



LA COLLINA PRODUKTDATEN

PRODUCT INFORMATION
INFORMATION PRODUITS

Bretz

TRUE CHARACTERS



Z 111LI LA COLLINA ▶ 304 CM ▼ 198 CM ▲ 99 CM
STOFF · FABRIC · TISSU 65 BOH02 / 68 5519 / 66 8439

LA COLLINA- ICH BIN DANN MAL WEG

Ich liebe das turbulente Leben in der Stadt - meistens zumindest. Sogar dem Warten auf die Bahn kann ich etwas Gutes abgewinnen: Endlich mal Zeit für meinen Coffee-to-Go! Doch wenn es mir doch mal zu viel wird, habe ich immer noch sie: La Collina. Ich lasse mich fallen, sinke ein, atme tief durch. Ich lasse mich im sanften Rhythmus treiben und die Welt da draußen wird auf einmal ganz leise.

FACTS & HIGHLIGHTS

- Klassisch fließende Form neu interpretiert
- Geschwungene, hohe Rückenlehne verleiht einzigartige Silhouette
- Gut zur individuellen Sitzlandschaft kombinierbar
- Lange Sitzkissen ermöglichen entspanntes Liegen und schlafen
- Abziehbare Sitzkissen



A 111 LA COLLINA
▶ 105 CM ▼ 94 CM ▲ 125 CM
STOFF · FABRIC · TISSU 65 BOH02 / 68 5519

C 111 LA COLLINA ▶ 68 CM ▼ 50 CM ▲ 44 CM
STOFF · FABRIC · TISSU 65 BOH02



X 111LI LA COLLINA ▶ 198 CM ▼ 106 CM ▲ 99 CM
SITZKISSEN ▶ 171 CM ▼ 81 CM
STOFF · FABRIC · TISSU 65 BOH02



Z 111RE LA COLLINA ▶ 304 CM ◀ 198 CM ▲ 99 CM
STOFF · FABRIC · TISSU 66 8430 / 67 2635 / 66 8417

LA COLLINA - WELL, I'LL BE OFF THEN ...

I love the hustle and bustle of life in the city. Most of the time. I can even see the good side of having to wait for the train: I finally get a moment to enjoy my coffee-to-go! But if – now and again – I feel overwhelmed, I've always got her: La Collina. I let myself go, sink right down, breathe real deep. I let myself be swayed by the soft rhythms and the world outside is suddenly quite still.

FACTS & FEATURES

- A traditional, flowing form – reimagined
- A lofty, curvilinear backrest creates a silhouette all it's own
- Ideal for combining into an individual seating arrangement
- Long seat cushions are perfect for lounging or sleeping
- Removable seat cushions



X 111RE LA COLLINA ▶ 198 CM ◀ 106 CM ▲ 99 CM
SITZKISSEN ▶ 171 CM ◀ 81 CM
STOFF · FABRIC · TISSU 66 8430 / 67 2635 / 66 8417



A 111 LA COLLINA
▶ 105 CM ◀ 94 CM ▲ 125 CM
STOFF · FABRIC · TISSU 66 8430 / 67 2635



F-VRE 111 LA COLLINA ▶ 304 CM ▼ 240 CM ▲ 99 CM
STOFF · FABRIC · TISSU 65 BOH02 / 68 5519 / 65 7949

LA COLLINA - JE SUIS TROP BIEN NE MATTENDEZ PAS

J'aime l'atmosphère trépidante de la ville, du moins la plupart du temps. Même attendre le train pour moi, a ses avantages:

enfin le temps de prendre mon café - à emporter!

Mais quand c'est vraiment trop, je sais qu'elle m'attend: La Collina.

Plonger, m'enfouir, reprendre mon souffle. Je me laisse entraîner, je dérive en douceur et le monde au dehors retrouve sa quiétude.

CARACTÉRISTIQUES & HIGHLIGHTS

- Le haut dossier galbé lui confère une silhouette unique
- Forme fluide classique entièrement réinterprétée
- Facilement intégrable à l'espace canapés individuel
- Les coussins allongés des sièges invitent à la détente et au repos prolongés
- Housses de siège amovibles



A 111 LA COLLINA ▶ 105 CM ▼ 94 CM ▲ 125 CM
STOFF · FABRIC · TISSU 65 BOH02



F 111 LA COLLINA ▶ 240 CM ▼ 106 CM ▲ 99 CM
STOFF · FABRIC · TISSU 65 BOH06 / 68 5585



COLLECTION LA COLLINA



G 111RE LA COLLINA > 318 CM ▾ 106 CM ▲ 99 CM
STOFF · FABRIC · TISSU 65 BOH02 / 68 5519 / 65 7949



F 111 LA COLLINA > 240 CM ▾ 106 CM ▲ 99 CM
STOFF · FABRIC · TISSU 66 8480



X 111RE LA COLLINA > 198 CM ▾ 106 CM ▲ 99 CM
STOFF · FABRIC · TISSU 65 BOH02

COLLECTION LA COLLINA



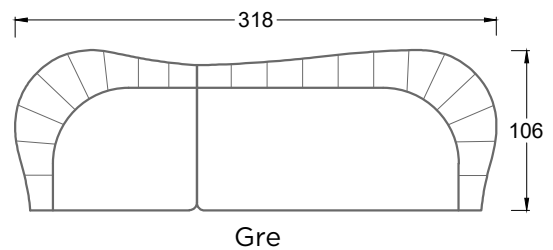
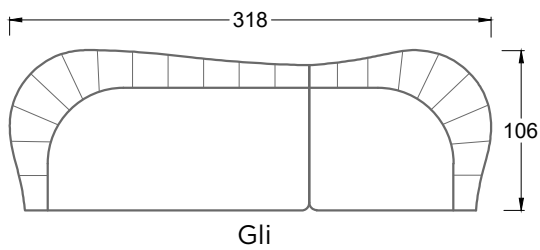
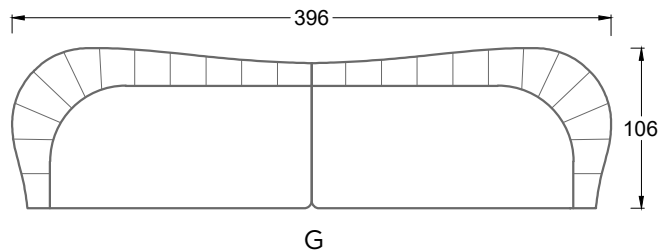
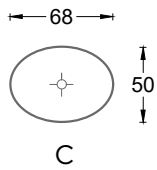
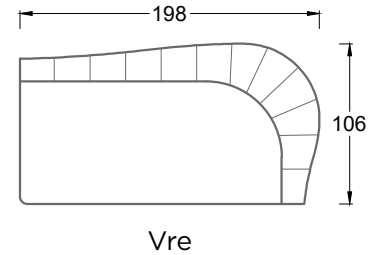
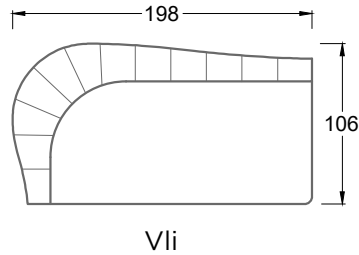
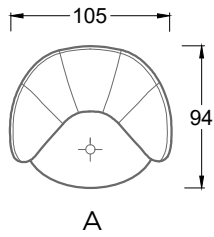
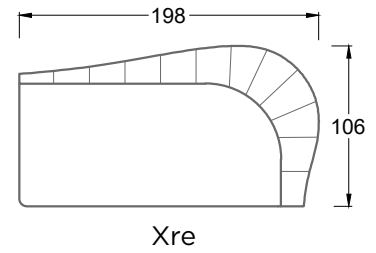
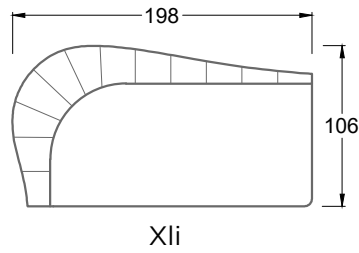
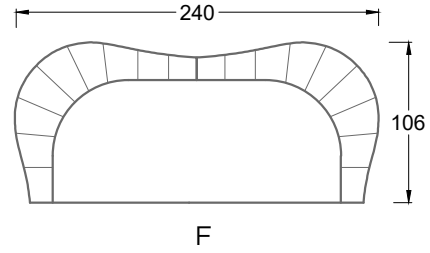
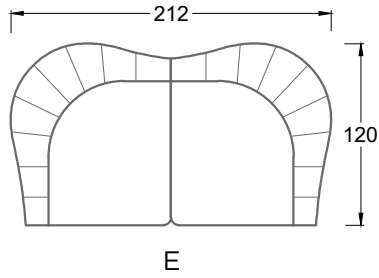
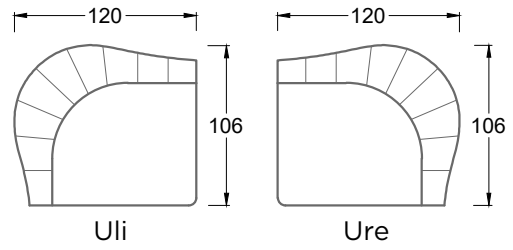
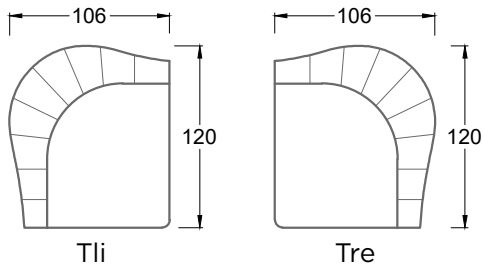

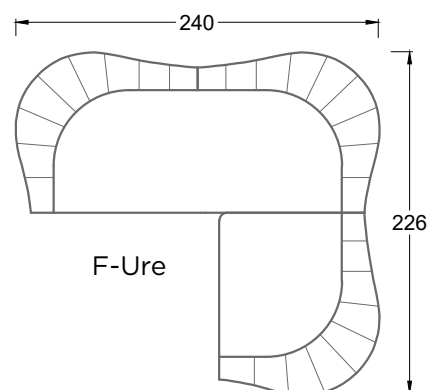
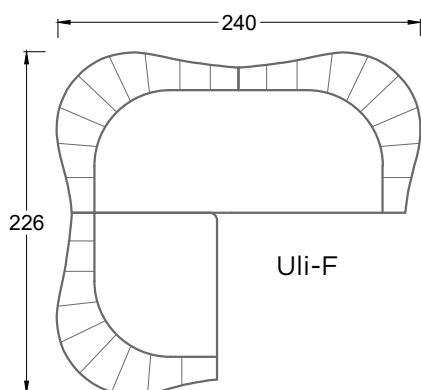
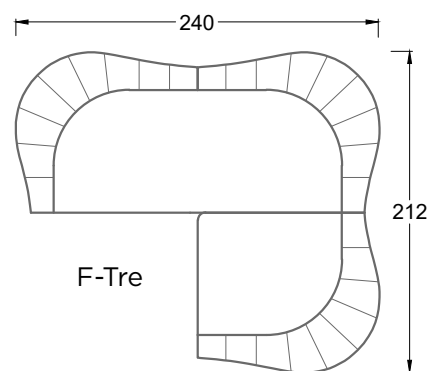
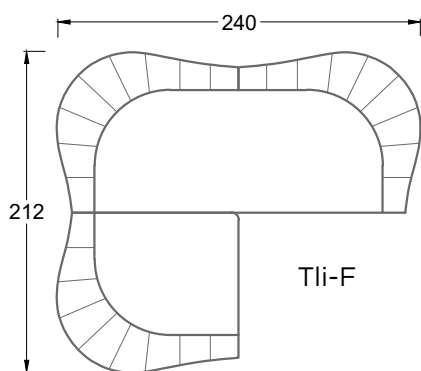
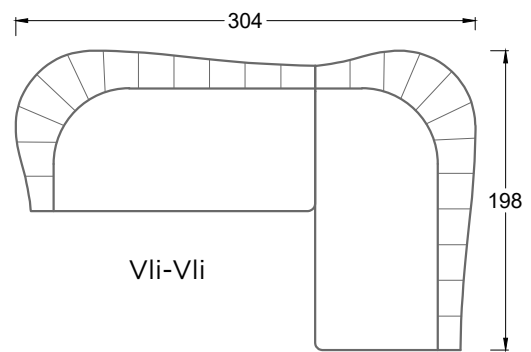
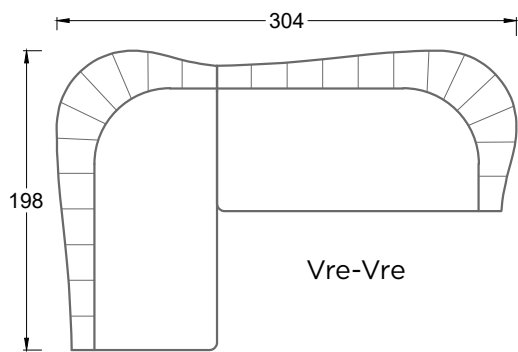
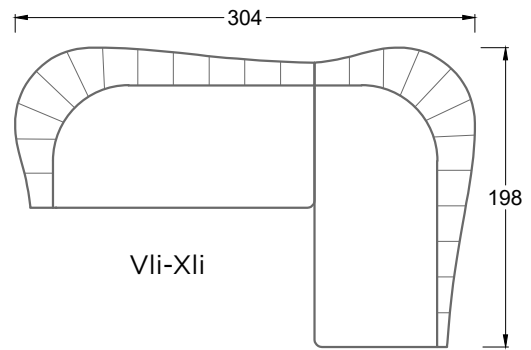
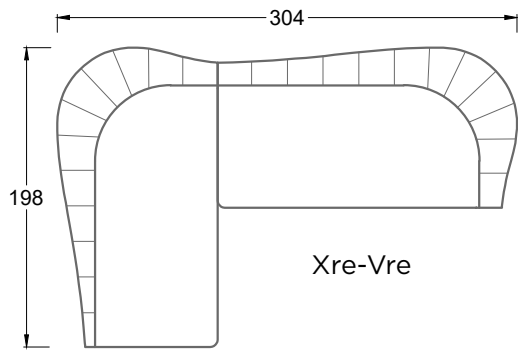
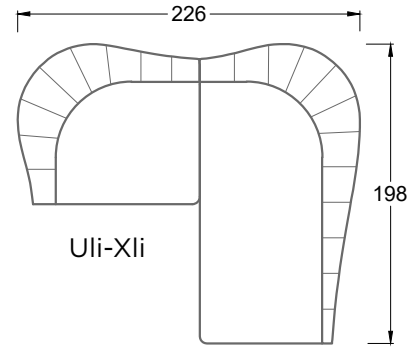
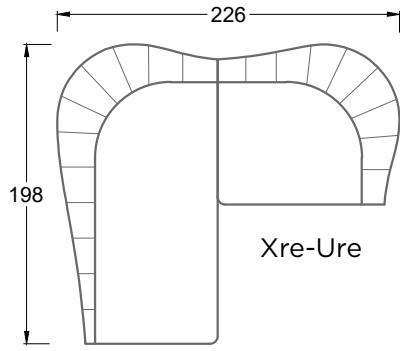

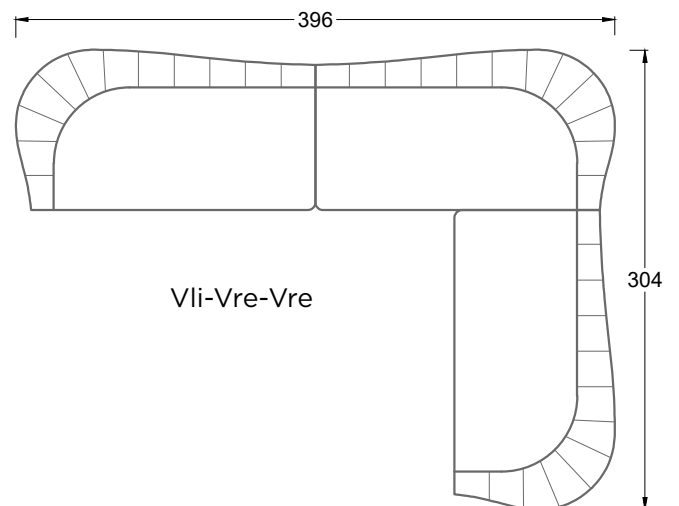
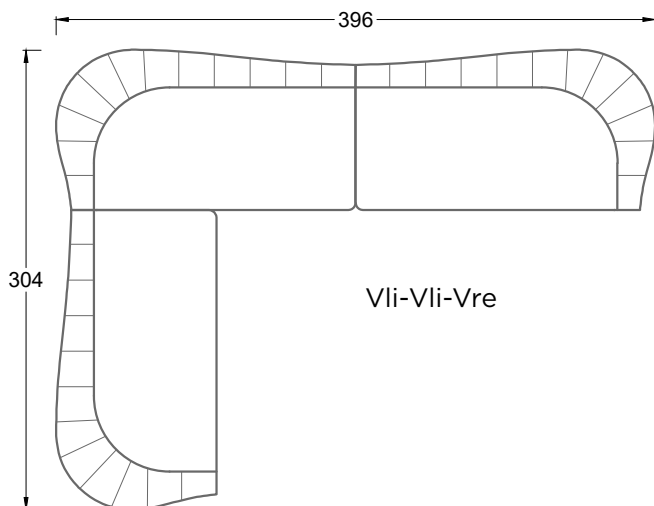
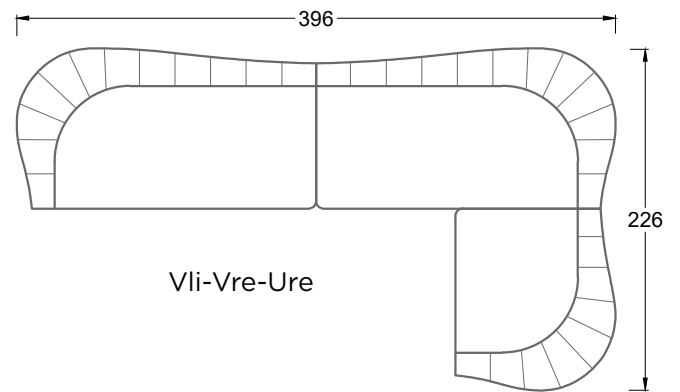
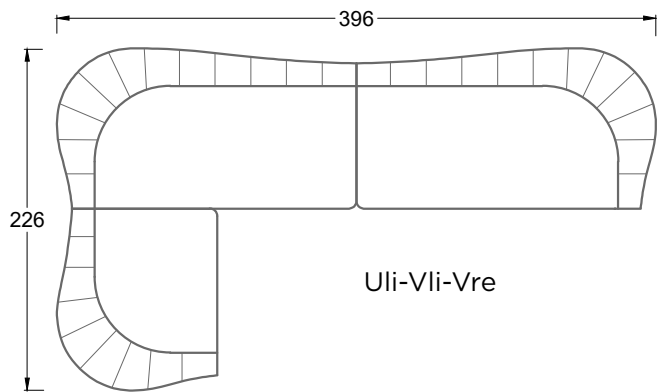
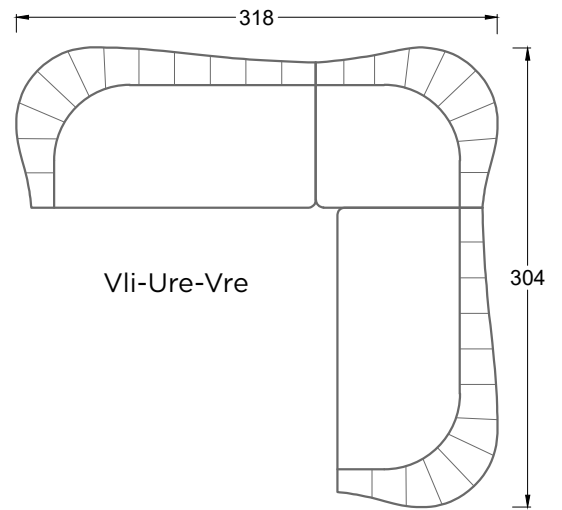
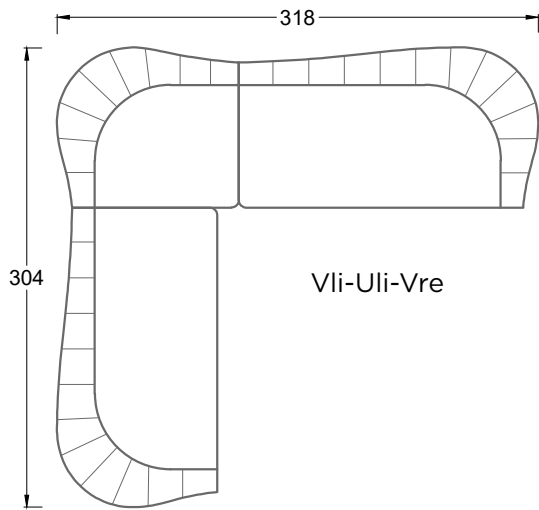
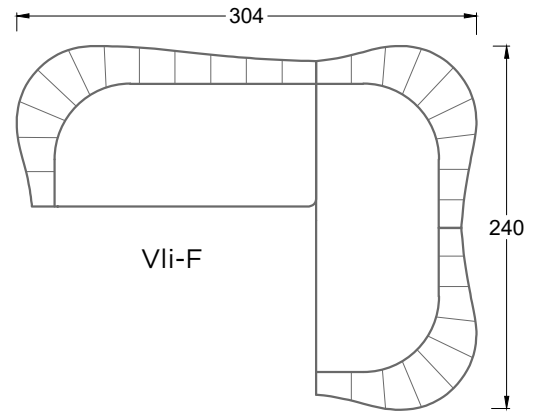
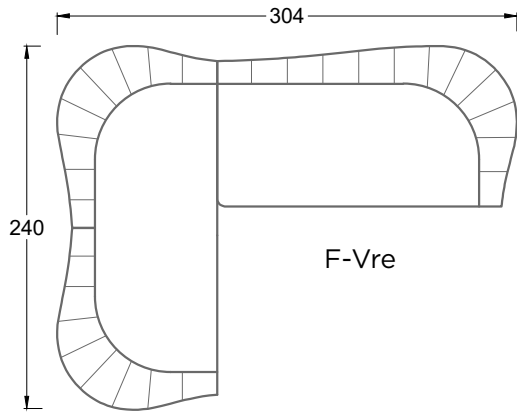

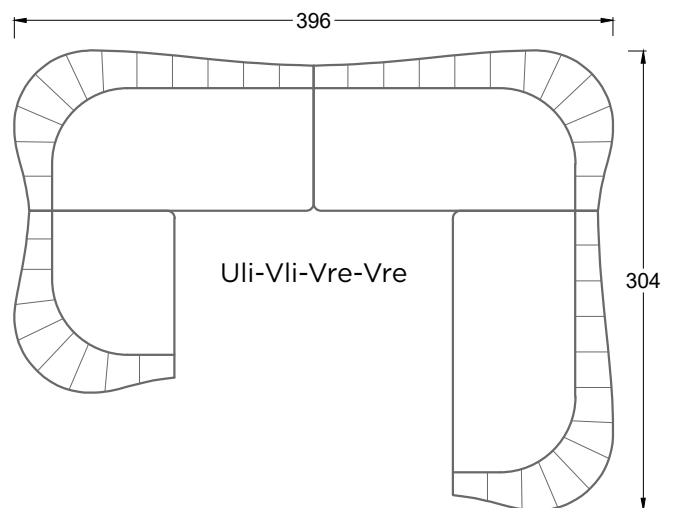
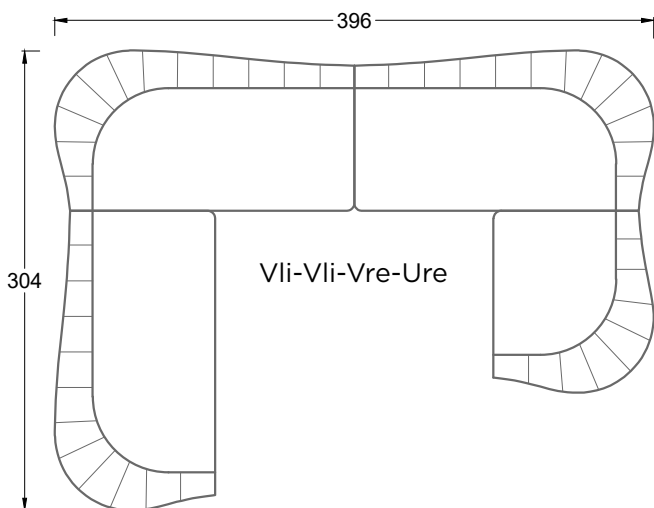
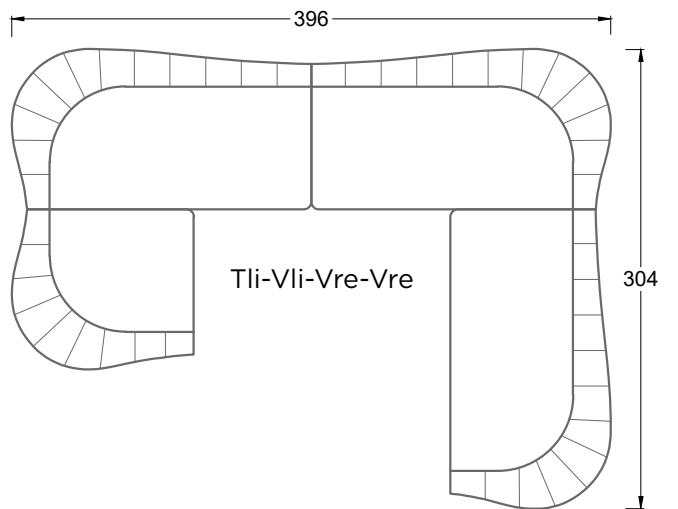
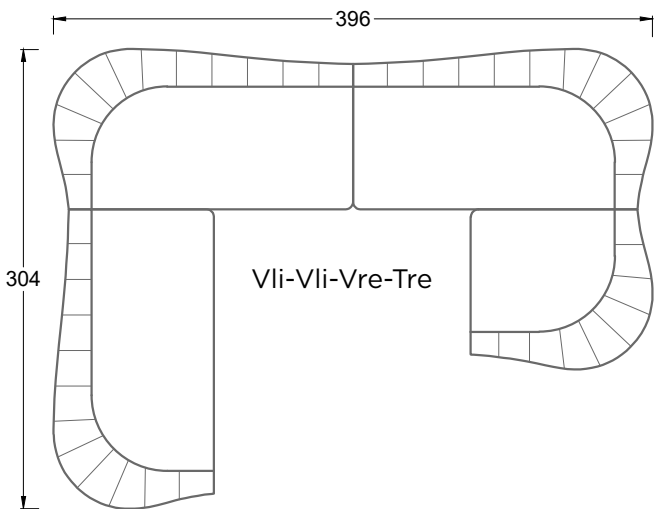
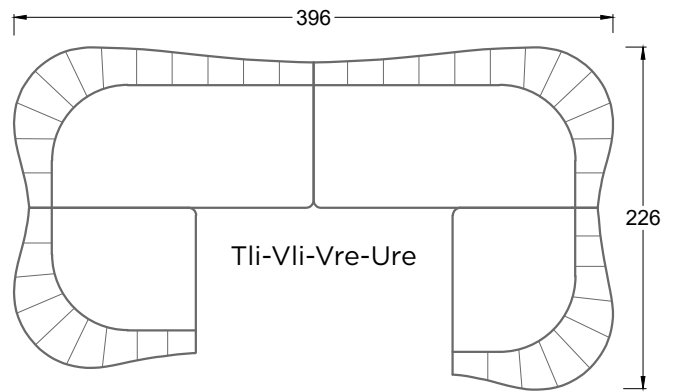
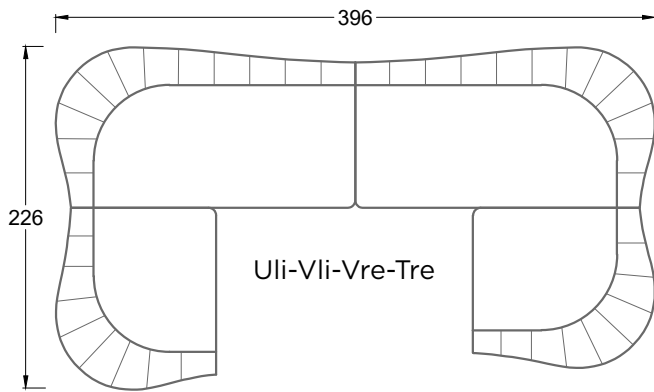
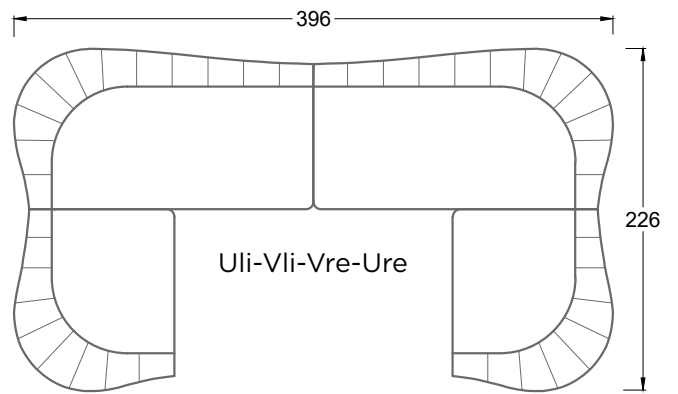
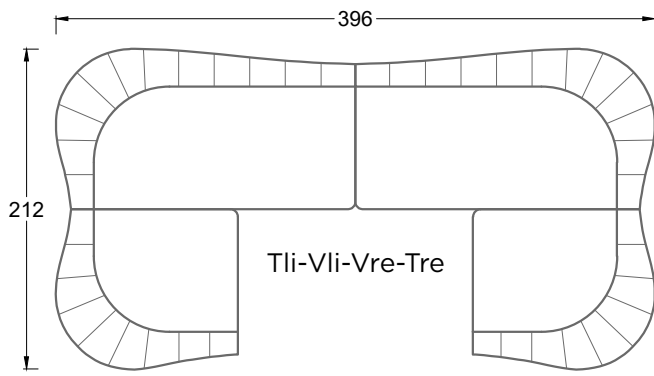



Bretz

TRUE CHARACTERS